



AVANCE
F L O O R S

TRULY
YOURS



Choose your own unique floor in *Six Simple Steps*



Avance
Floors
Truly
Yours

- Affordable top quality
- Quality hardwood, finished with care
- A wide range of styles
- Low maintenance
- Sustainable production

"We want our shop to be more than just a retail store; we want to offer our customers an experience. An attractive and well thought-out interior design is a major factor in creating the right atmosphere."

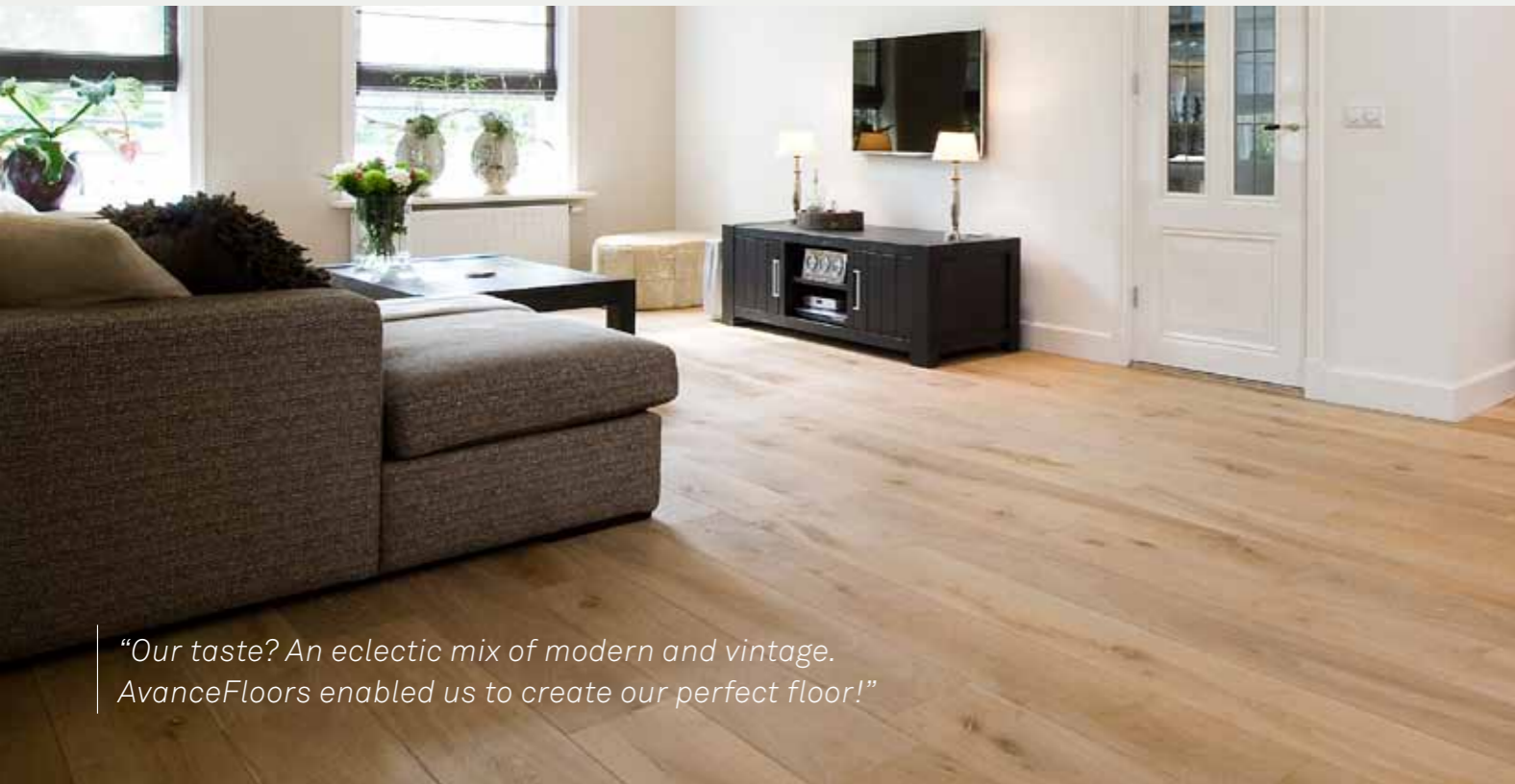

"Our taste? An eclectic mix of modern and vintage. AvanceFloors enabled us to create our perfect floor!"



CHOOSE YOUR OWN UNIQUE FLOOR IN SIX SIMPLE STEPS

STEP 1 CHOOSE YOUR FLOOR TYPE

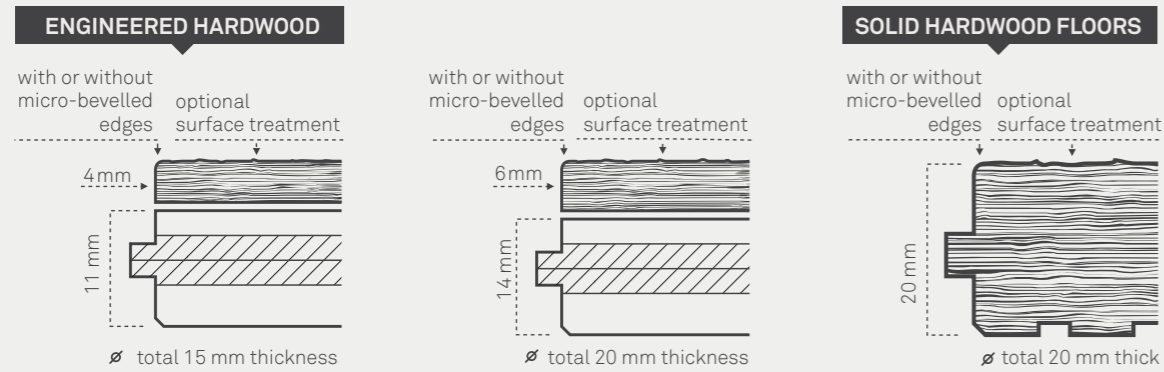

STEP 2 CHOOSE YOUR COLOUR

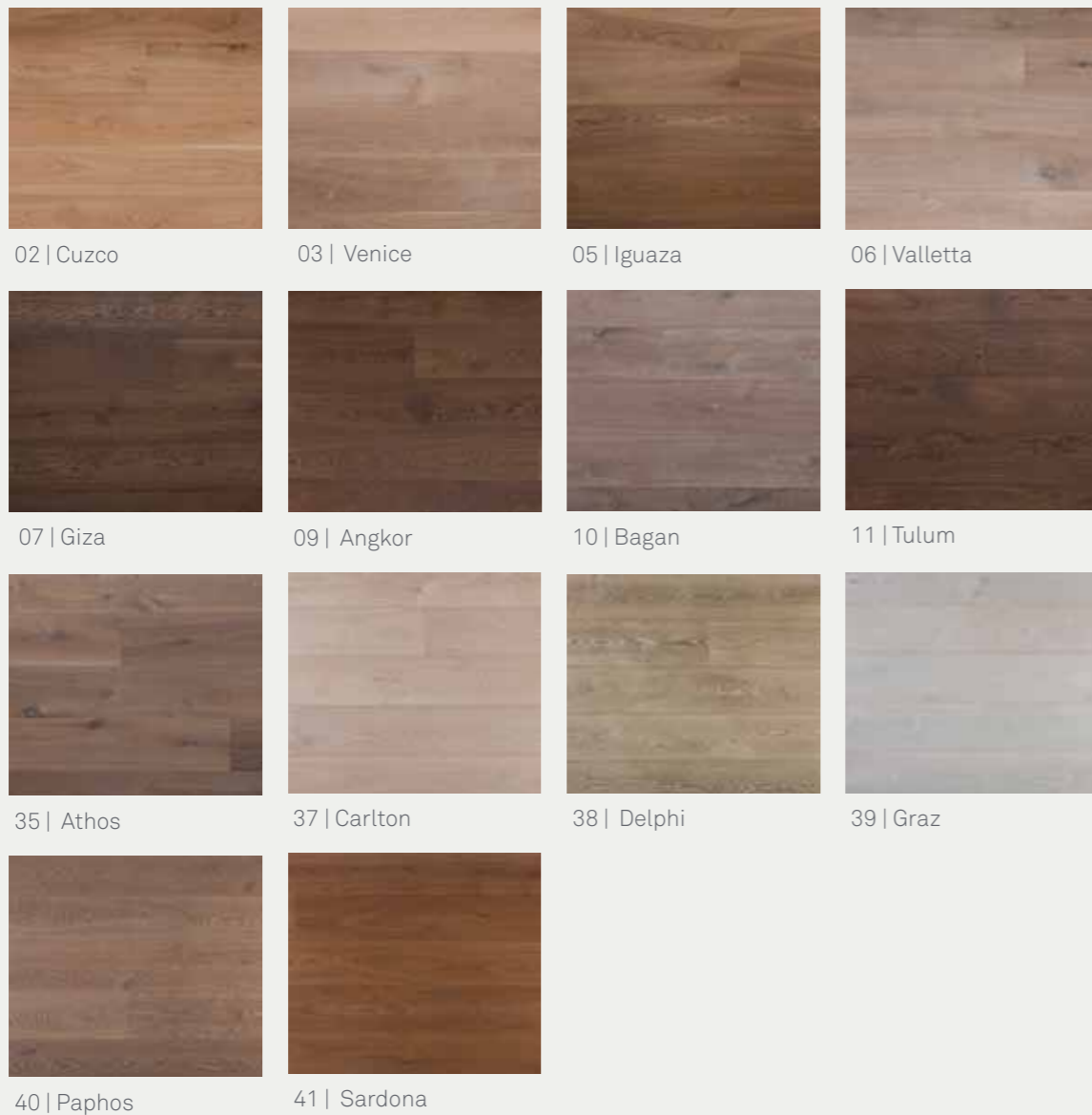

STEP 3 CHOOSE YOUR PATTERN

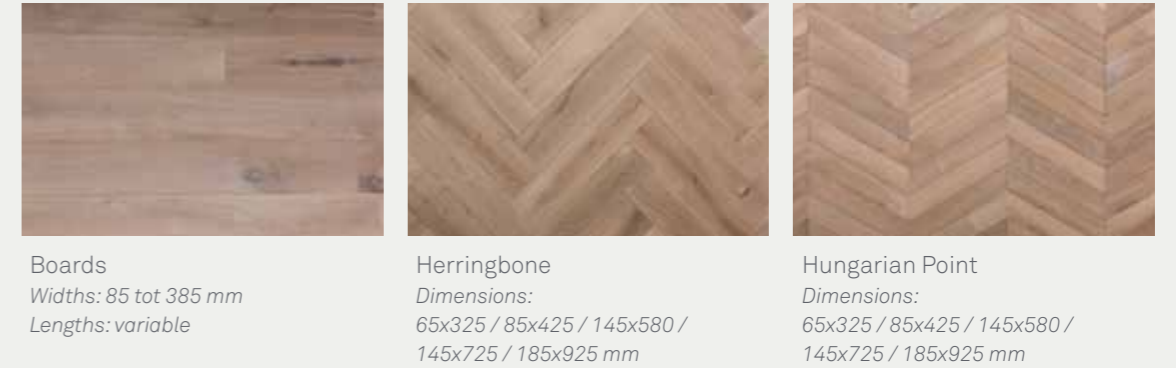

STEP 4 CHOOSE YOUR QUALITY

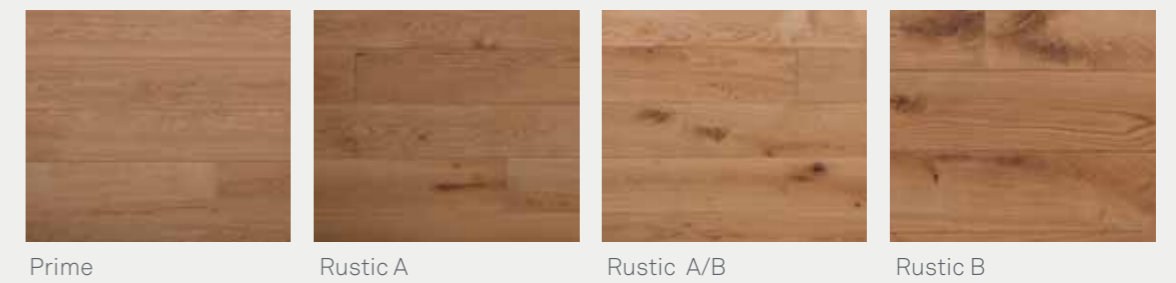

STEP 5 CHOOSE YOUR FINISHING

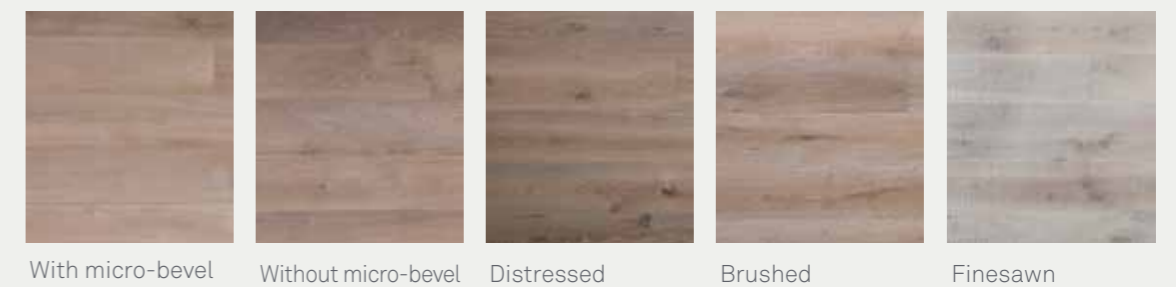

STEP 6 CHOOSE YOUR ACCESSORIES

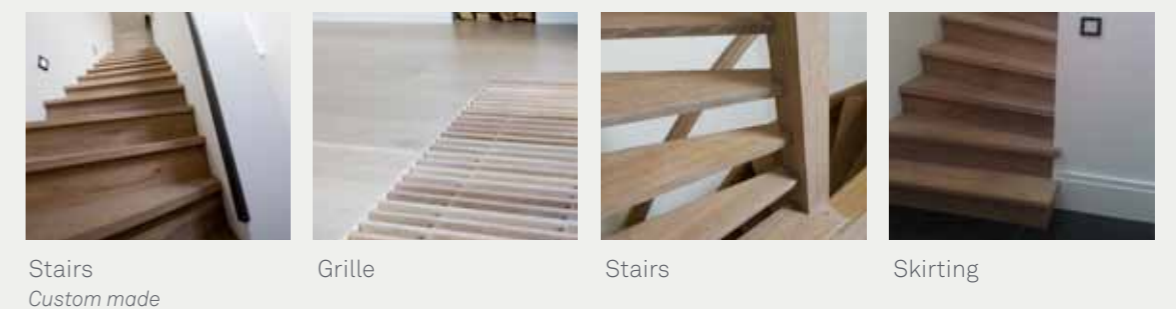



"Our conference rooms are all about business deals and innovative ideas. Our choice of materials? Tasteful and top quality, without predominating."



"Three kids, dogs, cats... Our wooden floor certainly had its share of use and abuse. We can say from experience: An AvanceFloors floor REALLY lasts a lifetime!"



hard·wood [hahrd-wood]

1. the hard, compact wood or timber of various trees, as the oak, cherry, maple, or mahogany.
2. a tree yielding such wood.
3. made or constructed of hardwood: a hardwood floor.



Hardwood floors by AvanceFloors are custom-made from premium quality, sustainably hardwood. Our love of craftsmanship allows us to take your personal wishes into account while keeping things affordable. Try our Six Simple Steps selection process for an ideal floor that will last you a lifetime.

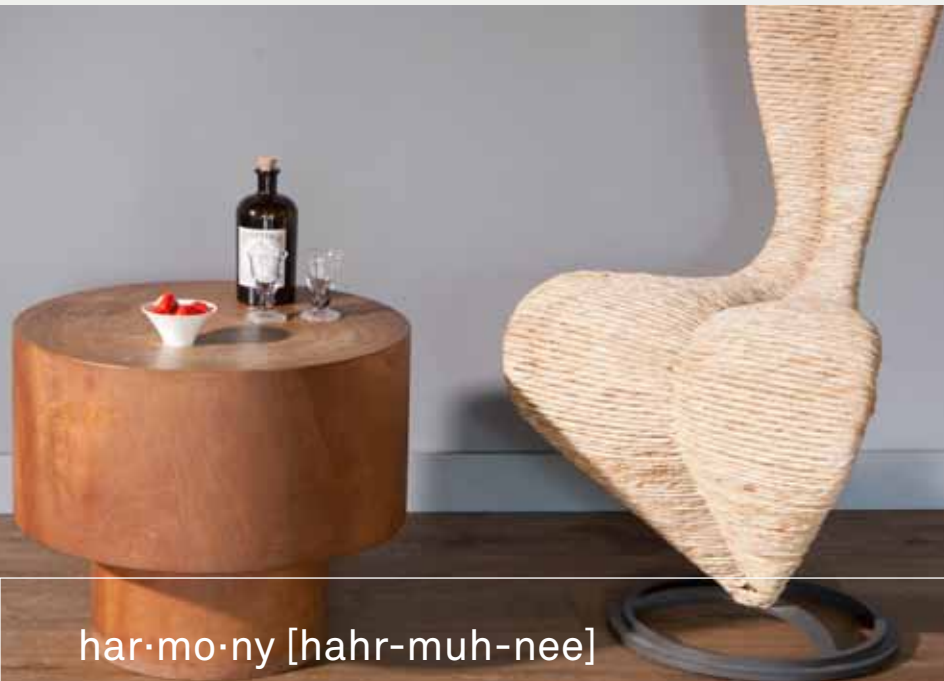

har·mo·ny [hahr-muh-nee]

1. agreement; accord; harmonious relations.
2. a consistent, orderly, or pleasing arrangement of parts; congruity.

CONTACT

Tel: +31 (0)73 611 06 06
Fax: +31 (0)73 611 06 11

sales@timberline.eu
www.avancefloors.com



EN 14342:2006 + A1:2008